

INSTALLATION MANUAL

Phoenix Multi 120Vac

12/1600/70
12/2500/120
24/1600/40
24/3000/70

Phoenix MultiPlus 120Vac

12/2500/120
24/3000/70

Phoenix Inverter 120Vac

12/1600
12/2500
24/1600
24/3000



Copyrights © 2003 Victron Energy B.V.
All Rights Reserved

This publication or parts thereof, may not be reproduced in any form, by any method, for any purpose.

For conditions of use and permission to use this manual for publication in other than the English language, contact Victron Energy B.V.

VICTRON ENERGY B.V. MAKES NO WARRANTY, EITHER EXPRESSED OR IMPLIED, INCLUDING BUT NOT LIMITED TO ANY IMPLIED WARRANTIES OF MERCHANTABILITY OR FITNESS FOR A PARTICULAR PURPOSE, REGARDING THESE VICTRON ENERGY PRODUCTS AND MAKES SUCH VICTRON ENERGY PRODUCTS AVAILABLE SOLELY ON AN "AS IS" BASIS.

IN NO EVENT SHALL VICTRON ENERGY B.V. BE LIABLE TO ANYONE FOR SPECIAL, COLLATERAL, INCIDENTAL, OR CONSEQUENTIAL DAMAGES IN CONNECTION WITH OR ARISING OUT OF PURCHASE OR USE OF THESE VICTRON ENERGY PRODUCTS. THE SOLE AND EXCLUSIVE LIABILITY TO VICTRON ENERGY B.V., REGARDLESS OF THE FORM OF ACTION, SHALL NOT EXCEED THE PURCHASE PRICE OF THE VICTRON ENERGY PRODUCTS DESCRIBED HEREIN.

Victron Energy B.V. reserves the right to revise and improve its products as it sees fit. This publication describes the state of this product at the time of its publication and may not reflect the product at all times in the future.

1. INSTALLATION



This product should be installed by a qualified electrician

1.1 Box Contents

- Phoenix Multi, MultiPlus, or Inverter
- User manual.
- Installation manual.
- Bag containing connection items, i.e.:
 - Temperature sensor.
 - Fuse (Mega fuse).
 - Four M8 nuts.
 - Four M8 washers.
 - Four M8 spring washers.
 - Charging current warning sticker.

1.2 Location

The product must be installed in a dry and well-ventilated area, as close as possible to the batteries. There should be a clear space of at least 10 cm around the appliance for cooling.



Excessively high ambient temperature will result in the following:

- Reduced service life.
- Reduced charging current.
- Reduced peak capacity, or shutdown of the inverter.

Never position the appliance directly above the batteries.

The product is suitable for wall mounting. The back of the enclosure has holes for wall mounting purposes, see Appendix B.

The appliance can be mounted horizontally as well as vertically; vertical mounting is preferable. The vertical position offers optimum cooling.



The interior of the product must remain accessible after installation.

Ensure that the AC and DC input cables are fitted with fuses and circuit breakers. Try and keep the distance between the product and the battery to a minimum in order to minimize cable voltage losses.



For safety purposes, this product should be installed in a heat-resistant environment if it is used with equipment where a substantial amount of power is to be converted. You should prevent the presence of e.g. chemicals, synthetic components, curtains or other textiles, etc., in the immediate vicinity.

1.3 Requirements

- Philips screwdriver (PH2) for removing the front.
- Flat screwdriver (0.6x3.5) for connecting the AC leads.
- Insulated box spanner (13 mm) for securing the terminal nuts and the fuse.
- Two battery cables (maximum length 6 meters) including battery terminals and cable ends.
- Three-wire cable.

1.4 Connection of Battery cables

In order to fully utilize the full capacity of the product, batteries with sufficient capacity and battery cables with sufficient cross section should be used. See table.

	12/1600/70	12/2500/120	24/1600/40	24/3000/70
Recommended battery capacity (Ah)	200 – 700	400 – 1200	100 – 400	200 – 700
Recommended cross section (mm ²) (0 – 6 m)	50	70	35	50

Remark: Internal resistance is the important factor when working with low capacity batteries. Please consult your supplier or the relevant sections of our book “electricity on board”, downloadable from our website.

Procedure

Proceed as follows to connect the battery cables:



Use an insulated box spanner in order to avoid shorting the battery. Avoid shorting the battery cables.

- Undo the four screws at the front of the enclosure and remove the front panel.
- Connect the battery cables: the + (red) on the right and the - (black) on the left, see Appendix A.
- Reverse polarity connection (+ to – and – to +) will cause the “reversed polarity” LED next to the terminal nuts to light up.
- Disconnect the cables and reconnect them correctly if the “reversed polarity” LED is illuminated.
- Tighten the connections after positioning the fastening items supplied with the product.
- Position the Mega fuse from the connection bag in position F4 and secure it, using the fastening items supplied with the product.
- Secure the nuts tightly in order to reduce the contact resistance as much as possible.

1.5 Connection of the AC cabling



The enclosure must be grounded for safety purposes. An earth screw has been fitted at the bottom side of the enclosure.

The terminal block can be found on the printed circuit board, see Appendix A. The shore or mains cable must be connected to the Multi with the aid of a three-wire cable. Use a three-wire cable with a flexible core and a cross section of 4 or 10 mm²

Procedure

Proceed as follows to connect the AC cables:

- The AC output cable can be connected directly to the terminal block containing the words "AC-out". The terminal points are indicated clearly. From left to right: "G" (earth), "N" (neutral) and "L" (phase).
- The AC input cable can be connected to the terminal block containing the words "AC-in". The terminal points are indicated clearly. "G" (earth) "N" (neutral) and "L" (phase).



The current which is switched through to the output is not fused. External fuses or current limiters have to be installed.

1.6 Optional Connections

A number of optional connections are possible:

1.6.1 Second Battery

The Phoenix Multi/ MultiPlus has a connection for charging a starter battery. For connection see Appendix A.

1.6.2 Voltage Sense (Phoenix Multi/ MultiPlus)

Two sense wires may be connected to compensate possible battery cable losses during charging. Use wires of at least 0.75mm². For connection see Appendix A.

1.6.3 Temperature Sensor (Phoenix Multi/ MultiPlus)

The temperature sensor supplied with the product may be used for temperature-compensated charging (see Appendix A). The sensor is insulated and must be mounted on the batteries minus pole.

1.6.4 Remote Control

The product can be operated remotely in two ways.

- Use of only an external switch.
- With the aid of a remote control panel.

For connection of the switch see Appendix A.

Observe the following when using only an external switch:

- Only functions if the switch on the product is switched to the "on" position.
- Not to be connected if a remote control panel is connected.

For connection of a remote control panel, see Appendix A.

Observe the following when using a remote control panel:

- Only functions if the switch on the product is switched to the "on" position.

1.6.5 External Relay (Phoenix Multi/ MultiPlus)

The maximum current that can be switched through from the AC input to the AC output is 30 A. At more than 30 A an external contactor is needed: please consult your supplier.

1.6.6 Parallel Connection

The product can be connected in parallel using several identical models, see Appendix G. The batteries must be connected in accordance with Appendix E or F. This requires interconnecting the products with the aid of a special cable to be supplied by Victron Energy, in conjunction with a connection diagram.

Parallel connection requires compliance with the following conditions:

- No more than five units should be connected in parallel.
- Only identical models should be connected in parallel.
- Ensure sufficient battery capacity is available.
- The prescribed cable cross sections (between battery and distribution point) must be multiplied with the number of appliances to be connected in parallel.
- Position the products close to each other but ensure there is adequate clearance for ventilation, min. 10 cm.
- The temperature sensor, voltage sensor and remote control must be connected to the master.
- The cables for each appliance must be equal in length (AC and DC).

1.6.7 3-phase operation^{multiplus}

The Phoenix MultiPlus can also be used in a 3-phase system, see Appendix 0. The batteries must be connected in accordance with Appendix E or F. The following conditions should be complied with in the case of 3-phase operation:

- Only identical models should be used.
- Ensure sufficient battery capacity is available.
- Position the products close to each other but ensure there is adequate clearance for ventilation (min. 10 cm)
- The temperature sensor and voltage sensor should preferably be connected to all three products.
- Only a single remote control can be connected, using splitters.

1.7 Grounding

When the input voltage of the Phoenix Multi is not switched through, the neutral of “AC-out” is connected to ground by means of a relay. This function can be disabled by removing the wire between the neutral of “AC-OUT” and J100.

2. SETTINGS



- Settings may only be changed by a qualified engineer
- Carefully read the instructions before changes are made.
- When setting the charger, all connections to the battery must be disconnected from the Phoenix Multi or MultiPlus.
- Do not use non-rechargeable batteries.
- The Phoenix Multi/ MultiPlus default settings are for charging Sonnenschein Dryfit A200 gel batteries. For the recommended battery voltage see section 2.4.
- Batteries should be placed in a dry and well-ventilated area during charging.

2.1 Settings – General

Settings may be changed with the aid of pushbuttons and dip switches (see Appendix A). Dipswitches are used to activate set-up, and to determine the setting to be changed. The value of this setting can be changed with the aid of the pushbuttons. The value specified is shown on the LEDs. Sections 2.1.3 and 2.1.4 describe how the LEDs can be read.

2.1.1 Default Settings

To restore the default settings, both pushbuttons should be held down for 3 seconds while set-up is activated.

Activate Set-up

Activate set-up with DS8 switched to On	Select a setting using DS3 - DS7 and set the new value using the pushbuttons.	Store the settings by changing the position of one of the switches DS3-DS7	Close set-up by switching DS8 to Off

DS-1 and DS-2 are not used and must be switched to Off.

NOTE: The new value is stored by changing the position of one of the switches DS3-DS7. The new value is NOT stored if set-up is closed without changing the position of one of the switches DS3-DS7. This offers an escape route if the change is not to be implemented.

2.1.2 Reading LEDs – setting values (Multi/ MultiPlus only)

The value of a setting can be determined on the basis of the following formula:

$$Value\ set = setting\ number * scale + offset$$

The 'offset' and the 'scale' are specified for each setting.

The setting number is indicated as follows via the LEDs:

The LEDs are divided into 2 columns of 4 LEDs each.

Each column indicates the numbers 0 - 9.

These columns together indicate 2-digit numbers.

The left column indicates the left-hand digit. The right-hand column shows the right-hand digit.

The digit in a column can be determined by adding the separate 'LED values'.

A flashing LED counts as 1 and an illuminated LED as 2.

A special case is 4 flashing LEDs. This signifies a 9.

<i>Symbol</i>	<i>Meaning</i>	<i>LED value</i>
○	LED off	0
☀	LED flashes	1
●	LED lit up	2
☀ ☀ ☀ ☀	All LEDs in a column are flashing	9

Examples of setting numbers:

<table style="width: 100%; border-collapse: collapse;"> <tr><td>○</td><td>0</td><td>○</td><td>0</td></tr> <tr><td>○</td><td>0</td><td>●</td><td>2</td></tr> <tr><td>○</td><td>0</td><td>●</td><td>2</td></tr> <tr><td>○</td><td>0</td><td>●</td><td>2</td></tr> <tr><td colspan="2" style="border-top: 1px solid black; border-bottom: 1px solid black;">0</td><td colspan="2" style="border-top: 1px solid black; border-bottom: 1px solid black;">6</td></tr> </table>	○	0	○	0	○	0	●	2	○	0	●	2	○	0	●	2	0		6		=6
○	0	○	0																		
○	0	●	2																		
○	0	●	2																		
○	0	●	2																		
0		6																			

<table style="width: 100%; border-collapse: collapse;"> <tr><td>○</td><td>0</td><td>☀</td><td>1</td></tr> <tr><td>○</td><td>0</td><td>●</td><td>2</td></tr> <tr><td>●</td><td>2</td><td>●</td><td>2</td></tr> <tr><td>●</td><td>2</td><td>●</td><td>2</td></tr> <tr><td colspan="2" style="border-top: 1px solid black; border-bottom: 1px solid black;">4</td><td colspan="2" style="border-top: 1px solid black; border-bottom: 1px solid black;">7</td></tr> </table>	○	0	☀	1	○	0	●	2	●	2	●	2	●	2	●	2	4		7		=47
○	0	☀	1																		
○	0	●	2																		
●	2	●	2																		
●	2	●	2																		
4		7																			

<table style="width: 100%; border-collapse: collapse;"> <tr><td>○</td><td>0</td><td>☀</td><td></td></tr> <tr><td>○</td><td>0</td><td>☀</td><td></td></tr> <tr><td>☀</td><td>1</td><td>☀</td><td></td></tr> <tr><td>●</td><td>2</td><td>☀</td><td></td></tr> <tr><td colspan="2" style="border-top: 1px solid black; border-bottom: 1px solid black;">3</td><td colspan="2" style="border-top: 1px solid black; border-bottom: 1px solid black;">9</td></tr> </table>	○	0	☀		○	0	☀		☀	1	☀		●	2	☀		3		9		=39
○	0	☀																			
○	0	☀																			
☀	1	☀																			
●	2	☀																			
3		9																			

The increments can be smaller than the reading (scale value). In that case, a pushbutton should be pressed repeatedly before the LED indication changes.

2.1.3 Reading LEDs – on-off (Multi/ MultiPlus only)

In addition to the facility of setting a value, there is an on- off facility. This allows for switching on/ off a particular setting, or for activating/ deactivating it. The left-hand column offers possibility A and the right-hand column offers possibility B in the case of a dual choice setting.

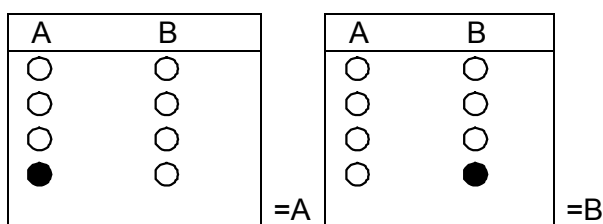

The default setting is always A.

The definitions for A and B are shown with the value to be set.

2.1.4 Default settings

System frequency	60 Hz
Inverter Voltage	120 Vac
Charger on/ off	on
Charger characteristic	Adaptive with battery protection mode
Charging Current	75% of maximum charging current
Battery Type Presets	type 1
Absorption Voltage	14.4/ 28.8 Vdc
Absorption Time / Maximum Absorption Time	4 hours
Float Voltage	13.8/ 27.6 Vdc
Repeated Absorption Time	1 hour
Repeated Absorption Interval	7 days
Bulk Protection On/ Off	on
Mains Waveform Check	on
Generator/ Shore Current	30 A
Generator/ Shore Support	off
3-phase Setting	off
Master/ slave	slave

2.2 System Frequency

The product can operate at 50Hz as well as at 60Hz.

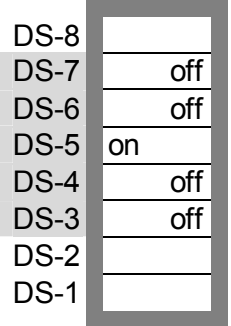
Set the DS 3-7	Specify the frequency	Example										
	<p>Specify the required frequency. The default setting is 60Hz. The left row of LEDs is for 50Hz. The right row of LEDs is for 60Hz. Press the buttons until the required LED indication appears.</p>	<p>Required: frequency is 60Hz. LED indication =</p> <table border="1" data-bbox="970 515 1316 694"> <thead> <tr> <th>50Hz</th> <th>60Hz</th> </tr> </thead> <tbody> <tr><td><input type="radio"/></td><td><input type="radio"/></td></tr> <tr><td><input type="radio"/></td><td><input type="radio"/></td></tr> <tr><td><input type="radio"/></td><td><input type="radio"/></td></tr> <tr><td><input type="radio"/></td><td><input checked="" type="radio"/></td></tr> </tbody> </table>	50Hz	60Hz	<input type="radio"/>	<input type="radio"/>	<input type="radio"/>	<input type="radio"/>	<input type="radio"/>	<input type="radio"/>	<input type="radio"/>	<input checked="" type="radio"/>
50Hz	60Hz											
<input type="radio"/>	<input type="radio"/>											
<input type="radio"/>	<input type="radio"/>											
<input type="radio"/>	<input type="radio"/>											
<input type="radio"/>	<input checked="" type="radio"/>											

2.3 Inverter Settings

Inverter Voltage

The inverter voltage can be set at between 94Vac-128Vac.

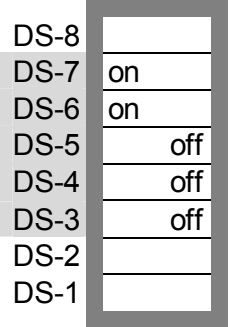
Set the DS 3-7	Specify the voltage	Example																								
	<p>Specify the required voltage V_q. Determine the setting number: $scale=1V$ $offset=94V$ setting $number=(V_q-94)$ Determine the LED indication. Press the pushbuttons until the required LED indication is displayed.</p>	<p>Required: voltage is 119V. Setting number = $119-94 = 25$. LED indication =</p> <table border="1" data-bbox="970 1232 1276 1422"> <tbody> <tr><td><input type="radio"/></td><td>0</td><td><input type="radio"/></td><td>0</td></tr> <tr><td><input type="radio"/></td><td>0</td><td><input checked="" type="radio"/></td><td>1</td></tr> <tr><td><input type="radio"/></td><td>0</td><td><input checked="" type="radio"/></td><td>2</td></tr> <tr><td><input checked="" type="radio"/></td><td>2</td><td><input checked="" type="radio"/></td><td>2</td></tr> <tr><td colspan="2"><hr/></td><td colspan="2"><hr/></td></tr> <tr><td colspan="2">2</td><td colspan="2">5</td></tr> </tbody> </table>	<input type="radio"/>	0	<input type="radio"/>	0	<input type="radio"/>	0	<input checked="" type="radio"/>	1	<input type="radio"/>	0	<input checked="" type="radio"/>	2	<input checked="" type="radio"/>	2	<input checked="" type="radio"/>	2	<hr/>		<hr/>		2		5	
<input type="radio"/>	0	<input type="radio"/>	0																							
<input type="radio"/>	0	<input checked="" type="radio"/>	1																							
<input type="radio"/>	0	<input checked="" type="radio"/>	2																							
<input checked="" type="radio"/>	2	<input checked="" type="radio"/>	2																							
<hr/>		<hr/>																								
2		5																								

Increment size is 1V.

NOTE: for setting the voltage of the Phoenix Inverter a voltage meter is to be used, because the Phoenix Inverter has only 4 LEDs.

2.4 Setting the Charger (Multi/ MultiPlus only)

When setting the charger, all connections between the battery and the Phoenix Multi must be disconnected.

Please read our book “electricity on board”

(downloadable from our website www.victronenergy.com) for details and suggestions about charging batteries.

Charger On/ Off

The Phoenix Multi charger can be switched off if required.

The default is on.

Set the DS 3-7	Switch the charger on or off	Example										
DS-8 <input type="checkbox"/> DS-7 <input type="checkbox"/> on DS-6 <input type="checkbox"/> off DS-5 <input type="checkbox"/> off DS-4 <input type="checkbox"/> on DS-3 <input type="checkbox"/> off DS-2 <input type="checkbox"/> DS-1 <input type="checkbox"/>	Determine whether the charger is to be switched on or off. The default is On. The left-hand LED column is for On. The right-hand LED column is for Off. Press the pushbuttons until the required LED indication is displayed.	Required: charger is off. LED indication = <table border="1" style="margin-left: 20px;"> <thead> <tr> <th>On</th> <th>Off</th> </tr> </thead> <tbody> <tr> <td><input type="radio"/></td> <td><input type="radio"/></td> </tr> <tr> <td><input type="radio"/></td> <td><input type="radio"/></td> </tr> <tr> <td><input type="radio"/></td> <td><input type="radio"/></td> </tr> <tr> <td><input type="radio"/></td> <td><input checked="" type="radio"/></td> </tr> </tbody> </table>	On	Off	<input type="radio"/>	<input type="radio"/>	<input type="radio"/>	<input type="radio"/>	<input type="radio"/>	<input type="radio"/>	<input type="radio"/>	<input checked="" type="radio"/>
On	Off											
<input type="radio"/>	<input type="radio"/>											
<input type="radio"/>	<input type="radio"/>											
<input type="radio"/>	<input type="radio"/>											
<input type="radio"/>	<input checked="" type="radio"/>											

Charging Characteristics

The Phoenix Multi/ MultiPlus has 3 pre-programmed charging characteristics.

Fixed Charging Characteristic:

The absorption period is a fixed preset period. Following the absorption mode, the charger switches to float. In order to “refresh” the battery, the charger periodically switches back to absorption.

Adaptive Charging Characteristic:

The absorption period depends on the charge delivered during bulk. This is followed by float phase lasting 24 hours, after which the voltage is reduced by an additional 0,8 V resp. 1,6 V for 12 V resp. 24 V batteries. (reduced float). As with the Fixed-charging characteristic, the charger will periodically switch back to absorption.

Adaptive Charging Characteristic with batterySafe mode (default setting):

If, in order to quickly charge a battery, a high charge current in combination with a high absorption voltage has been chosen, the Phoenix charger will prevent damage due to excessive gassing by automatically limiting the rate of voltage increase once the gassing voltage has been reached

Set the DS 3-7	Set the charging characteristic	Example																								
DS-8 <input type="checkbox"/> DS-7 <input type="checkbox"/> off DS-6 <input type="checkbox"/> on DS-5 <input type="checkbox"/> on DS-4 <input type="checkbox"/> on DS-3 <input type="checkbox"/> off DS-2 <input type="checkbox"/> DS-1 <input type="checkbox"/>	Determine the required charging characteristic: 1: Fixed 2: Adaptive 3: Adaptive with BatterySafe mode (default) Press the pushbuttons until the required LED indication is displayed.	Required: charging characteristic is Fixed. Setting number = 1. LED indication = <table border="1" style="margin-left: 20px;"> <tr><td><input type="checkbox"/></td><td>0</td><td><input type="checkbox"/></td><td>0</td></tr> <tr><td><input type="checkbox"/></td><td>0</td><td><input type="checkbox"/></td><td>0</td></tr> <tr><td><input type="checkbox"/></td><td>0</td><td><input type="checkbox"/></td><td>0</td></tr> <tr><td><input type="checkbox"/></td><td>0</td><td><input checked="" type="checkbox"/></td><td>1</td></tr> <tr><td colspan="2"><hr/></td><td colspan="2"><hr/></td></tr> <tr><td colspan="2">0</td><td colspan="2">1</td></tr> </table>	<input type="checkbox"/>	0	<input type="checkbox"/>	0	<input type="checkbox"/>	0	<input type="checkbox"/>	0	<input type="checkbox"/>	0	<input type="checkbox"/>	0	<input type="checkbox"/>	0	<input checked="" type="checkbox"/>	1	<hr/>		<hr/>		0		1	
<input type="checkbox"/>	0	<input type="checkbox"/>	0																							
<input type="checkbox"/>	0	<input type="checkbox"/>	0																							
<input type="checkbox"/>	0	<input type="checkbox"/>	0																							
<input type="checkbox"/>	0	<input checked="" type="checkbox"/>	1																							
<hr/>		<hr/>																								
0		1																								

Charging Current

The default charging current is 75% of the maximum charging current. This current will be too high for most applications. For most battery types the optimal charging current is 0.1-0.2x the battery capacity,

Set the DS 3-7	Set the charging current	Example																								
DS-8 <input type="checkbox"/> DS-7 <input type="checkbox"/> off DS-6 <input type="checkbox"/> on DS-5 <input type="checkbox"/> off DS-4 <input type="checkbox"/> off DS-3 <input type="checkbox"/> off DS-2 <input type="checkbox"/> DS-1 <input type="checkbox"/>	Determine the required charging current I_q . Determine the setting number. <i>Scale = 2A</i> <i>Offset = 0A</i> <i>Setting number = $I_q/2$</i> Determine the LED indication. Press the pushbuttons until the required LED indication is displayed.	Battery capacity is 450Ah. The recommended maximum charging current is $450 \cdot 0.2 = 90A$. Setting number = $90/2 = 45$. LED indication = <table border="1" style="margin-left: 20px;"> <tr><td><input type="checkbox"/></td><td>0</td><td><input type="checkbox"/></td><td>0</td></tr> <tr><td><input type="checkbox"/></td><td>0</td><td><input checked="" type="checkbox"/></td><td>1</td></tr> <tr><td><input checked="" type="checkbox"/></td><td>2</td><td><input checked="" type="checkbox"/></td><td>2</td></tr> <tr><td><input checked="" type="checkbox"/></td><td>2</td><td><input checked="" type="checkbox"/></td><td>2</td></tr> <tr><td colspan="2"><hr/></td><td colspan="2"><hr/></td></tr> <tr><td colspan="2">4</td><td colspan="2">5</td></tr> </table>	<input type="checkbox"/>	0	<input type="checkbox"/>	0	<input type="checkbox"/>	0	<input checked="" type="checkbox"/>	1	<input checked="" type="checkbox"/>	2	<input checked="" type="checkbox"/>	2	<input checked="" type="checkbox"/>	2	<input checked="" type="checkbox"/>	2	<hr/>		<hr/>		4		5	
<input type="checkbox"/>	0	<input type="checkbox"/>	0																							
<input type="checkbox"/>	0	<input checked="" type="checkbox"/>	1																							
<input checked="" type="checkbox"/>	2	<input checked="" type="checkbox"/>	2																							
<input checked="" type="checkbox"/>	2	<input checked="" type="checkbox"/>	2																							
<hr/>		<hr/>																								
4		5																								

Increment size is 1A.

Battery Type Presets

A number of battery type presets simplify the process of setting the absorption/ float voltage and maximum absorption time:

	Battery type	Absorption voltage		Float voltage		Maximum absorption time
0	User-specified					
1	Sonnenschein Dryfit A200 Gel	14.4 V	28.8 V	13.8 V/ 13.2V	27.6 V/ 26.4V	4 hours
2	Traction	15.0 V	30.0 V	13.8 V/ 13.2V	27.6 V/ 26.4V	6 hours
3	Semi-traction ¹	14.4 V	28.8 V	14.0 V/ 13.2V	28.0 V/ 26.4V	5 hours
4	Victory ¹	14.8 V	29.6 V	14.0 V/ 13.2V	28.0 V/ 26.4V	5 hours

¹The optimal absorption voltage for flat plate lead acid batteries is subject to mechanical and chemical properties. Batteries with high antimony content can typically be charged with a lower absorption voltage than batteries with low antimony content, such as the Victron carbon fiber battery. (Please refer to our book "Electricity on Board" downloadable from our website www.victronenergy.com)

Set the DS 3-7	Set the battery type	Example																				
DS-8 <input type="checkbox"/> DS-7 <input type="checkbox"/> on DS-6 <input type="checkbox"/> on DS-5 <input type="checkbox"/> off DS-4 <input type="checkbox"/> off DS-3 <input type="checkbox"/> on DS-2 <input type="checkbox"/> DS-1 <input type="checkbox"/>	Determine the battery type used. Determine the setting numbers with the aid of the table. Press the keys until the required LED indication is displayed. NOTE: 0 cannot be selected but will be displayed if the absorption voltage, the float voltage or the absorption time is changed.	Required: the battery type is Victory: Setting number = 4. LED indication = <table border="1" style="margin-left: auto; margin-right: auto;"> <tr> <td><input type="radio"/></td><td>0</td> <td><input type="radio"/></td><td>0</td> </tr> <tr> <td><input type="radio"/></td><td>0</td> <td><input type="radio"/></td><td>0</td> </tr> <tr> <td><input type="radio"/></td><td>0</td> <td><input checked="" type="radio"/></td><td>2</td> </tr> <tr> <td><input type="radio"/></td><td>0</td> <td><input checked="" type="radio"/></td><td>2</td> </tr> <tr> <td colspan="2" style="text-align: center;">0</td> <td colspan="2" style="text-align: center;">4</td> </tr> </table>	<input type="radio"/>	0	<input type="radio"/>	0	<input type="radio"/>	0	<input type="radio"/>	0	<input type="radio"/>	0	<input checked="" type="radio"/>	2	<input type="radio"/>	0	<input checked="" type="radio"/>	2	0		4	
<input type="radio"/>	0	<input type="radio"/>	0																			
<input type="radio"/>	0	<input type="radio"/>	0																			
<input type="radio"/>	0	<input checked="" type="radio"/>	2																			
<input type="radio"/>	0	<input checked="" type="radio"/>	2																			
0		4																				

The default setting is the Sonnenschein Dryfit A200 battery. Contact your battery supplier for the correct charge voltages and change the voltage settings if required.

Absorption Voltage

The absorption voltage can be set at 12-16/ 24-32V. Battery, the T-sense and V-sense must be disconnected during setting.

Set the DS 3-7	Set the absorption voltage	Example																				
DS-8 <input type="checkbox"/> DS-7 <input type="checkbox"/> off DS-6 <input type="checkbox"/> off DS-5 <input type="checkbox"/> off DS-4 <input type="checkbox"/> off DS-3 <input type="checkbox"/> off DS-2 <input type="checkbox"/> DS-1 <input type="checkbox"/>	Determine the required absorption voltage V_q . Determine the setting number. $Scale = 0.1V$ $Offset = 12/24V$ $Setting\ number = (V_q - 24)/0.1$ Determine the LED indication. Press the pushbuttons until the required LED indication is displayed.	Required: absorption voltage is 28.5V. $Setting\ number = (28.5 - 24)/0.1 = 45$. LED indication = <table border="1" style="margin-left: 20px;"> <tr> <td><input type="checkbox"/></td><td>0</td> <td><input type="checkbox"/></td><td>0</td> </tr> <tr> <td><input type="checkbox"/></td><td>0</td> <td><input checked="" type="checkbox"/></td><td>1</td> </tr> <tr> <td><input checked="" type="checkbox"/></td><td>2</td> <td><input checked="" type="checkbox"/></td><td>2</td> </tr> <tr> <td><input checked="" type="checkbox"/></td><td>2</td> <td><input checked="" type="checkbox"/></td><td>2</td> </tr> <tr> <td colspan="2" style="border-top: 1px solid black;">4</td> <td colspan="2" style="border-top: 1px solid black;">5</td> </tr> </table>	<input type="checkbox"/>	0	<input type="checkbox"/>	0	<input type="checkbox"/>	0	<input checked="" type="checkbox"/>	1	<input checked="" type="checkbox"/>	2	<input checked="" type="checkbox"/>	2	<input checked="" type="checkbox"/>	2	<input checked="" type="checkbox"/>	2	4		5	
<input type="checkbox"/>	0	<input type="checkbox"/>	0																			
<input type="checkbox"/>	0	<input checked="" type="checkbox"/>	1																			
<input checked="" type="checkbox"/>	2	<input checked="" type="checkbox"/>	2																			
<input checked="" type="checkbox"/>	2	<input checked="" type="checkbox"/>	2																			
4		5																				

Increment size is 0.05 V.

Absorption Time/ Maximum Absorption Time

This setting defines the absorption period in the case of the fixed charging characteristic and the maximum absorption time in the case of the adaptive charging characteristic.

The (maximum) absorption time can be set from 1 to 8 hours.

Set the DS 3-7	Set the (maximum) absorption time	Example																				
DS-8 <input type="checkbox"/> DS-7 <input type="checkbox"/> on DS-6 <input type="checkbox"/> off DS-5 <input type="checkbox"/> on DS-4 <input type="checkbox"/> on DS-3 <input type="checkbox"/> off DS-2 <input type="checkbox"/> DS-1 <input type="checkbox"/>	Determine the required (maximum) absorption time T_q . Determine the setting number. $Scale = 1\ hour$ $Offset = 0$ $Setting\ number = T_q$ Determine the LED indication. Press the pushbuttons until the required LED indication is displayed.	Required: (maximum) absorption time is 4 hours. $Setting\ number = 4$. LED indication = <table border="1" style="margin-left: 20px;"> <tr> <td><input type="checkbox"/></td><td>0</td> <td><input type="checkbox"/></td><td>0</td> </tr> <tr> <td><input type="checkbox"/></td><td>0</td> <td><input type="checkbox"/></td><td>0</td> </tr> <tr> <td><input type="checkbox"/></td><td>0</td> <td><input checked="" type="checkbox"/></td><td>2</td> </tr> <tr> <td><input type="checkbox"/></td><td>0</td> <td><input checked="" type="checkbox"/></td><td>2</td> </tr> <tr> <td colspan="2" style="border-top: 1px solid black;">0</td> <td colspan="2" style="border-top: 1px solid black;">4</td> </tr> </table>	<input type="checkbox"/>	0	<input type="checkbox"/>	0	<input type="checkbox"/>	0	<input type="checkbox"/>	0	<input type="checkbox"/>	0	<input checked="" type="checkbox"/>	2	<input type="checkbox"/>	0	<input checked="" type="checkbox"/>	2	0		4	
<input type="checkbox"/>	0	<input type="checkbox"/>	0																			
<input type="checkbox"/>	0	<input type="checkbox"/>	0																			
<input type="checkbox"/>	0	<input checked="" type="checkbox"/>	2																			
<input type="checkbox"/>	0	<input checked="" type="checkbox"/>	2																			
0		4																				

Increments are 1 hour.

Float Voltage

The float voltage can be set at 12-16/ 24-32V. Battery, the T-sense and V-sense must be disconnected during setting.

Set the DS 3-7	Set the float voltage	Example																																								
<table border="1"> <tr><td>DS-8</td><td></td></tr> <tr><td>DS-7</td><td>on</td></tr> <tr><td>DS-6</td><td>off</td></tr> <tr><td>DS-5</td><td>off</td></tr> <tr><td>DS-4</td><td>off</td></tr> <tr><td>DS-3</td><td>off</td></tr> <tr><td>DS-2</td><td></td></tr> <tr><td>DS-1</td><td></td></tr> </table>	DS-8		DS-7	on	DS-6	off	DS-5	off	DS-4	off	DS-3	off	DS-2		DS-1		<p>Determine the required float voltage V_q.</p> <p>Determine the setting number.</p> <p><i>Scale = 0.1V</i></p> <p><i>Minimum = 12/24V</i></p> <p><i>Setting number = $(V_q - 24)/0.1$</i></p> <p>Determine the LED indication.</p> <p>Press the pushbuttons until the required LED indication is displayed.</p>	<p>Required: float voltage is 28.5V.</p> <p>Setting number = $(28.5 - 24)/0.1 = 45$.</p> <p>LED indication =</p> <table border="1"> <tr><td>○</td><td>0</td><td>○</td><td>0</td></tr> <tr><td>○</td><td>0</td><td>☀</td><td>1</td></tr> <tr><td>●</td><td>2</td><td>●</td><td>2</td></tr> <tr><td>●</td><td>2</td><td>●</td><td>2</td></tr> <tr><td colspan="2"><hr/></td><td colspan="2"><hr/></td></tr> <tr><td colspan="2">4</td><td colspan="2">5</td></tr> </table>	○	0	○	0	○	0	☀	1	●	2	●	2	●	2	●	2	<hr/>		<hr/>		4		5	
DS-8																																										
DS-7	on																																									
DS-6	off																																									
DS-5	off																																									
DS-4	off																																									
DS-3	off																																									
DS-2																																										
DS-1																																										
○	0	○	0																																							
○	0	☀	1																																							
●	2	●	2																																							
●	2	●	2																																							
<hr/>		<hr/>																																								
4		5																																								

Increment size is 0.05 V.

Absorption

Repeated Absorption Time

The repeated absorption time can be set at 1 – 72 quarters of an hour.

Set the DS 3-7	Set the repeated absorption time	Example																																								
<table border="1"> <tr><td>DS-8</td><td></td></tr> <tr><td>DS-7</td><td>on</td></tr> <tr><td>DS-6</td><td>on</td></tr> <tr><td>DS-5</td><td>on</td></tr> <tr><td>DS-4</td><td>off</td></tr> <tr><td>DS-3</td><td>off</td></tr> <tr><td>DS-2</td><td></td></tr> <tr><td>DS-1</td><td></td></tr> </table>	DS-8		DS-7	on	DS-6	on	DS-5	on	DS-4	off	DS-3	off	DS-2		DS-1		<p>Determine the required Repeated absorption time T_q in quarters of an hour.</p> <p>Determine the setting number.</p> <p><i>Scale = 1 quarter of an hour</i></p> <p><i>Offset = 0</i></p> <p><i>Setting number = T_q</i></p> <p>Determine the LED indication.</p> <p>Press the pushbuttons until the required LED indication is displayed.</p>	<p>Required: Repeated absorption time is 1 hour.</p> <p>Setting number = 1 hour = 4 quarters of an hour</p> <p>LED indication =</p> <table border="1"> <tr><td>○</td><td>0</td><td>○</td><td>0</td></tr> <tr><td>○</td><td>0</td><td>○</td><td>0</td></tr> <tr><td>○</td><td>0</td><td>●</td><td>2</td></tr> <tr><td>○</td><td>0</td><td>●</td><td>2</td></tr> <tr><td colspan="2"><hr/></td><td colspan="2"><hr/></td></tr> <tr><td colspan="2">0</td><td colspan="2">4</td></tr> </table>	○	0	○	0	○	0	○	0	○	0	●	2	○	0	●	2	<hr/>		<hr/>		0		4	
DS-8																																										
DS-7	on																																									
DS-6	on																																									
DS-5	on																																									
DS-4	off																																									
DS-3	off																																									
DS-2																																										
DS-1																																										
○	0	○	0																																							
○	0	○	0																																							
○	0	●	2																																							
○	0	●	2																																							
<hr/>		<hr/>																																								
0		4																																								

Increment size is a quarter of an hour.

Repeated Absorption Interval

The repeated absorption interval, can be set at 1 – 45 days.

Set the DS 3-7	Set the repeated absorption interval	Example																																				
<table border="1"> <tr><td>DS-8</td><td></td></tr> <tr><td>DS-7</td><td>off</td></tr> <tr><td>DS-6</td><td>off</td></tr> <tr><td>DS-5</td><td>off</td></tr> <tr><td>DS-4</td><td>on</td></tr> <tr><td>DS-3</td><td>off</td></tr> <tr><td>DS-2</td><td></td></tr> <tr><td>DS-1</td><td></td></tr> </table>	DS-8		DS-7	off	DS-6	off	DS-5	off	DS-4	on	DS-3	off	DS-2		DS-1		<p>Determine the required reduced float time T_q.</p> <p>Determine the setting number.</p> <p style="padding-left: 40px;"><i>Scale = 1 day</i></p> <p style="padding-left: 40px;"><i>Offset = 0</i></p> <p style="padding-left: 40px;"><i>Setting number = T_q</i></p> <p>Determine the LED indication.</p> <p>Press the pushbuttons until the required LED indication is displayed.</p>	<p>Required: reduced float time is 1 week.</p> <p>Setting number = 7.</p> <p>LED indication =</p> <table border="1" style="margin-left: auto; margin-right: auto;"> <tr> <td><input type="radio"/></td><td>0</td> <td><input checked="" type="radio"/></td><td>1</td> </tr> <tr> <td><input type="radio"/></td><td>0</td> <td><input checked="" type="radio"/></td><td>2</td> </tr> <tr> <td><input type="radio"/></td><td>0</td> <td><input checked="" type="radio"/></td><td>2</td> </tr> <tr> <td><input type="radio"/></td><td>0</td> <td><input checked="" type="radio"/></td><td>2</td> </tr> <tr> <td colspan="2" style="border-top: 1px solid black;">0</td> <td colspan="2" style="border-top: 1px solid black;">7</td> </tr> </table>	<input type="radio"/>	0	<input checked="" type="radio"/>	1	<input type="radio"/>	0	<input checked="" type="radio"/>	2	<input type="radio"/>	0	<input checked="" type="radio"/>	2	<input type="radio"/>	0	<input checked="" type="radio"/>	2	0		7	
DS-8																																						
DS-7	off																																					
DS-6	off																																					
DS-5	off																																					
DS-4	on																																					
DS-3	off																																					
DS-2																																						
DS-1																																						
<input type="radio"/>	0	<input checked="" type="radio"/>	1																																			
<input type="radio"/>	0	<input checked="" type="radio"/>	2																																			
<input type="radio"/>	0	<input checked="" type="radio"/>	2																																			
<input type="radio"/>	0	<input checked="" type="radio"/>	2																																			
0		7																																				

Increments are 1 day.

2.5 Special Settings

Bulk Protection On/ Off

If the charger has not reached the absorption voltage after 10 hours' charging in the bulk phase, the battery may be defective. In order to prevent further damage, the charger will automatically cut out after 10 hours' bulk. The "bulk" LED will start to flash.

This safety cut out can be switched off.

Set the DS 3-7	Switch the bulk cut-out to on or off	Example										
DS-8 <input type="checkbox"/> DS-7 <input type="checkbox"/> off DS-6 <input type="checkbox"/> on DS-5 <input type="checkbox"/> off DS-4 <input type="checkbox"/> on DS-3 <input type="checkbox"/> off DS-2 <input type="checkbox"/> DS-1 <input type="checkbox"/>	Determine whether the bulk cut out should be switched on or off. The default is On. The left-hand LED column is for On. The right-hand LED column is for Off. Press the pushbuttons until the required LED indication is displayed.	Required: bulk cut out is off. LED indication = <table border="1" style="margin-left: 20px;"> <thead> <tr> <th>On</th> <th>Off</th> </tr> </thead> <tbody> <tr><td><input type="checkbox"/></td><td><input type="checkbox"/></td></tr> <tr><td><input type="checkbox"/></td><td><input type="checkbox"/></td></tr> <tr><td><input type="checkbox"/></td><td><input type="checkbox"/></td></tr> <tr><td><input type="checkbox"/></td><td><input checked="" type="checkbox"/></td></tr> </tbody> </table>	On	Off	<input type="checkbox"/>	<input type="checkbox"/>	<input type="checkbox"/>	<input type="checkbox"/>	<input type="checkbox"/>	<input type="checkbox"/>	<input type="checkbox"/>	<input checked="" type="checkbox"/>
On	Off											
<input type="checkbox"/>	<input type="checkbox"/>											
<input type="checkbox"/>	<input type="checkbox"/>											
<input type="checkbox"/>	<input type="checkbox"/>											
<input type="checkbox"/>	<input checked="" type="checkbox"/>											

Mains Waveform Check

The Phoenix Multi checks if the mains voltage has not only the correct voltage, but also the correct shape. When the Phoenix Multi does not function properly on a generator this function can be disabled.

Set the DS 3-7	Switch the Mains Voltage Check to on or off	Example										
DS-8 <input type="checkbox"/> DS-7 <input type="checkbox"/> off DS-6 <input type="checkbox"/> on DS-5 <input type="checkbox"/> off DS-4 <input type="checkbox"/> off DS-3 <input type="checkbox"/> on DS-2 <input type="checkbox"/> DS-1 <input type="checkbox"/>	Determine whether the Mains Waveform Check should be switched on or off. The default is On. The left-hand LED column is for On. The right-hand LED column is for Off. Press the pushbuttons until the required LED indication is displayed.	Required: Mains Waveform Check is off. LED indication = <table border="1" style="margin-left: 20px;"> <thead> <tr> <th>On</th> <th>Off</th> </tr> </thead> <tbody> <tr><td><input type="checkbox"/></td><td><input type="checkbox"/></td></tr> <tr><td><input type="checkbox"/></td><td><input type="checkbox"/></td></tr> <tr><td><input type="checkbox"/></td><td><input type="checkbox"/></td></tr> <tr><td><input type="checkbox"/></td><td><input checked="" type="checkbox"/></td></tr> </tbody> </table>	On	Off	<input type="checkbox"/>	<input type="checkbox"/>	<input type="checkbox"/>	<input type="checkbox"/>	<input type="checkbox"/>	<input type="checkbox"/>	<input type="checkbox"/>	<input checked="" type="checkbox"/>
On	Off											
<input type="checkbox"/>	<input type="checkbox"/>											
<input type="checkbox"/>	<input type="checkbox"/>											
<input type="checkbox"/>	<input type="checkbox"/>											
<input type="checkbox"/>	<input checked="" type="checkbox"/>											

PowerControl – Dealing with limited generator or shore side power

The Multi is a very powerful battery charger. It will therefore draw a lot of current from the generator or shore side supply (nearly 10 A per Multi at 230 VAC). With the Phoenix Multi Control Panel (PMC) a maximum generator or shore current can be set. The Multi will then take account of other AC loads and use whatever is extra for charging, thus preventing the generator or shore supply from being overloaded.

It is also possible to set the max. generator/ shore current internally.

The generator/ shore current can be set at 1 - 30A.

Set the DS 3-7	Set the shore current	Example																				
	Determine the required shore current limitation I_q . Determine the setting number. $Scale = 1A$ $Offset = 0$ $Setting\ number = (I_q)/1$ Determine the LED indication. Press the pushbuttons until the required LED indication is displayed.	Required: shore current limitation is 16A. Setting number = 16. LED indication = <table border="1" style="margin-left: 20px;"> <tr> <td>○</td><td>0</td> <td>○</td><td>0</td> </tr> <tr> <td>○</td><td>0</td> <td>●</td><td>2</td> </tr> <tr> <td>○</td><td>0</td> <td>●</td><td>2</td> </tr> <tr> <td>☀</td><td>1</td> <td>●</td><td>2</td> </tr> <tr> <td></td><td><u>1</u></td> <td></td><td><u>6</u></td> </tr> </table>	○	0	○	0	○	0	●	2	○	0	●	2	☀	1	●	2		<u>1</u>		<u>6</u>
○	0	○	0																			
○	0	●	2																			
○	0	●	2																			
☀	1	●	2																			
	<u>1</u>		<u>6</u>																			

Increment size is 1A.

The remote control panel setting overrides the internal setting.

PowerAssist – Boosting the capacity of shore or generator power

The feature that distinguishes the Phoenix MultiPlus from the standard Multi is PowerAssist. This feature takes the principle of PowerControl to a further dimension allowing the MultiPlus to supplement the capacity of the alternative source. Where peak power is so often required only for a limited period, it is possible to reduce the size of generator needed or conversely enable more to be achieved from the typically limited shore connection. When the load reduces, the spare power is used to recharge the battery.

Note: minimum shore current 4 A or generator capacity 2,5 kW required per MultiPlus.

Set the DS 3-7	Switch the generator support on or off	Example										
	Determine whether the generator support should be on or off. The default is Off. The left-hand LED column is for Off. The right-hand LED column is for On. Press the pushbuttons until the required LED indication is displayed.	Required: generator support is on. LED indication = <table border="1" style="margin-left: 20px;"> <tr> <td>Off</td> <td>On</td> </tr> <tr> <td>○</td> <td>○</td> </tr> <tr> <td>○</td> <td>○</td> </tr> <tr> <td>○</td> <td>○</td> </tr> <tr> <td>○</td> <td>●</td> </tr> </table>	Off	On	○	○	○	○	○	○	○	●
Off	On											
○	○											
○	○											
○	○											
○	●											

3-phase Setting ^{MultiPlus}

Three identical units can t be interconnected for a 3-phase system, in accordance with Appendix 0. The batteries must be connected in accordance with Appendix E or F. A number of settings are then required for each unit.

Firstly, all units must be set for 3-phase operation.

Set the DS 3-7	Switch 3-phase operation on or off	Example																										
<table border="1"> <tr><td>DS-8</td><td></td></tr> <tr><td>DS-7</td><td>on</td></tr> <tr><td>DS-6</td><td>on</td></tr> <tr><td>DS-5</td><td>off</td></tr> <tr><td>DS-4</td><td>on</td></tr> <tr><td>DS-3</td><td>off</td></tr> <tr><td>DS-2</td><td></td></tr> <tr><td>DS-1</td><td></td></tr> </table>	DS-8		DS-7	on	DS-6	on	DS-5	off	DS-4	on	DS-3	off	DS-2		DS-1		<p>Determine whether 3-phase operation should be on or off. The default is Off. The left-hand LED column is for Off. The right-hand LED column is for On. Press the pushbuttons until the required LED indication is displayed.</p>	<p>Required: 3-phase operation is on. LED indication =</p> <table border="1"> <tr><td>Off</td><td>On</td></tr> <tr><td><input type="radio"/></td><td><input type="radio"/></td></tr> <tr><td><input type="radio"/></td><td><input type="radio"/></td></tr> <tr><td><input type="radio"/></td><td><input type="radio"/></td></tr> <tr><td><input type="radio"/></td><td><input checked="" type="radio"/></td></tr> </table>	Off	On	<input type="radio"/>	<input type="radio"/>	<input type="radio"/>	<input type="radio"/>	<input type="radio"/>	<input type="radio"/>	<input type="radio"/>	<input checked="" type="radio"/>
DS-8																												
DS-7	on																											
DS-6	on																											
DS-5	off																											
DS-4	on																											
DS-3	off																											
DS-2																												
DS-1																												
Off	On																											
<input type="radio"/>	<input type="radio"/>																											
<input type="radio"/>	<input type="radio"/>																											
<input type="radio"/>	<input type="radio"/>																											
<input type="radio"/>	<input checked="" type="radio"/>																											

One of the three units must be set as the "master" following this setting.. No further settings are required for the other units.

Set the DS 3-7	Set the master/ slave	Example																										
<table border="1"> <tr><td>DS-8</td><td></td></tr> <tr><td>DS-7</td><td>off</td></tr> <tr><td>DS-6</td><td>off</td></tr> <tr><td>DS-5</td><td>on</td></tr> <tr><td>DS-4</td><td>on</td></tr> <tr><td>DS-3</td><td>off</td></tr> <tr><td>DS-2</td><td></td></tr> <tr><td>DS-1</td><td></td></tr> </table>	DS-8		DS-7	off	DS-6	off	DS-5	on	DS-4	on	DS-3	off	DS-2		DS-1		<p>Determine master or slave. The default is slave. The left-hand LED column is for slave. The right-hand LED column is for the master. Press the pushbuttons until the required LED indication is displayed.</p>	<p>Required: this unit is the master. LED indication =</p> <table border="1"> <tr><td>slave</td><td>master</td></tr> <tr><td><input type="radio"/></td><td><input type="radio"/></td></tr> <tr><td><input type="radio"/></td><td><input type="radio"/></td></tr> <tr><td><input type="radio"/></td><td><input type="radio"/></td></tr> <tr><td><input type="radio"/></td><td><input checked="" type="radio"/></td></tr> </table>	slave	master	<input type="radio"/>	<input type="radio"/>	<input type="radio"/>	<input type="radio"/>	<input type="radio"/>	<input type="radio"/>	<input type="radio"/>	<input checked="" type="radio"/>
DS-8																												
DS-7	off																											
DS-6	off																											
DS-5	on																											
DS-4	on																											
DS-3	off																											
DS-2																												
DS-1																												
slave	master																											
<input type="radio"/>	<input type="radio"/>																											
<input type="radio"/>	<input type="radio"/>																											
<input type="radio"/>	<input type="radio"/>																											
<input type="radio"/>	<input checked="" type="radio"/>																											

2.6 Maintenance

The Phoenix Multi does not require specific maintenance. Annual checking of all connections and eventually removal of dust suffices. Protect the product from humidity and oil fumes and keep it as clean as possible.

3. TROUBLE SHOOTING TABLE

Proceed as follows for quick detection of common faults.

DC loads must be disconnected from the batteries and the AC loads must be disconnected from the inverter before the inverter and/ or battery charger is tested.

Consult your Victron Energy dealer if the fault cannot be resolved.

Problem	Cause	Solution
The inverter fails to operate when switched on.	The battery voltage is too high or too low.	Ensure that the battery voltage is within the correct value.
The “low battery” LED flashes.	The battery voltage is low.	Charge the battery or check the battery connections.
The “low battery” LED on.	The inverter cuts out because the battery voltage is too low.	Charge the battery or check the battery connections.
The “overload” LED flashes.	The load on the inverter is higher than the nominal load.	reduce the load.
The “overload” LED on.	The inverter cuts out due to excessive load.	reduce the load.
The “temperature” LED flashes or is on.	The ambient temperature is too high, or the load is excessive.	Place the inverter in a cool and well-ventilated room, or reduce the load.
The “low battery” and “overload” LEDs flash alternately.	Low battery voltage and excessive load.	Charge the batteries, reduce the load or install batteries with a higher capacity. Use shorter and/ or thicker battery cables.
The “low battery” and “overload” LEDs flash simultaneously.	Voltage ripple on the DC input exceeds 1.25Vrms.	Check the battery cables and terminals. Check the battery capacity; increase if necessary.
The “low battery” and “overload” LEDs are on.	The inverter cuts out as a result of excessive voltage ripple on the DC input.	Install batteries with a higher capacity. Use shorter and/ or thicker battery cables and reset the inverter (switch off and on again).
One LED alarm is on and the second LED is flashing	The inverter cut out as a result of the illuminated alarm indication (LED). The flashing LED indicates that the inverter nearly cut out as a result of the relevant alarm.	Check the table for the appropriate course of action.

Problem	Cause	Solution
The charger is not functioning	The mains voltage or mains frequency is out of range.	Ensure that the mains voltage is between 104 Vac and 130 Vac, and that the frequency matches the setting.
The battery is not being charged fully.	Incorrect charging current.	Set the charging current at between 0.1 and 0.2x battery capacity.
	A defective battery connection.	Check the battery terminals.
	The absorption voltage has been set to an incorrect value.	Adjust the absorption voltage to the correct value.
	The float voltage has been set to an incorrect value.	Adjust the float voltage to the correct value.
	The DC fuse is defective.	Replace the DC fuse.
The battery is overcharged.	The absorption voltage has been set to an incorrect value.	Adjust the absorption voltage to the correct value.
	The float voltage has been set to an incorrect value.	Adjust the float voltage to the correct value.
	A defective battery.	Replace the battery.
	The battery is too small.	Reduce the charging current or use a battery with a higher capacity.
	The battery is too hot.	Connect a temperature sensor.

4. TECHNICAL DATA

Phoenix	12/1600/70	12/2500/120	24/1600/40	24/3000/70
INVERTER and Multi/MultiPlus				
Input voltage range (V DC)	9,5-16,1	9,5-16,1	19,0-32,2	19,0-32,2
Output voltage (V AC)	120 ± 2%			
Frequency (Hz)	60 ± 0,1%			
Cont. output power at 25 °C (VA)	1600	2500	1600	3000
Cont. output power at 25 °C (W)	1300	2000	1300	2500
Cont. output power at 40 °C (W)	1200	1600	1200	2000
Peak power (W)	2300	4500	3000	6000
Maximum efficiency (%)	93	93	94	94
Zero-load (economy) power (W)	7.5	7.5	9	9
CHARGER (Multi/MultiPlus only)				
Input voltage range (V AC)	94-128			
Frequency (Hz)	60 ± 0,1%			
Power factor	1			
Charge voltage 'absorption' (V DC)	14,4	14,4	28,8	28,8
Charge voltage 'float' (V DC)	13,8	13,8	27,6	27,6
Storage mode (V DC)	13,2	13,2	26,4	26,4
Charge current house batt. (A)	70	120	40	70
Charge current starter batt. (A)	4	4	4	4
Battery capacity (Ah)	200-700	400-1200	100-400	200-700
Temperature sensor	√	√	√	√
GENERAL				
Forced cooling	√	√	√	√
Protection (2)	a - h			
Operating temp. range	0 - 50°C			
Humidity (non condensing)	max 95%			
ENCLOSURE				
Material & Colour	aluminium (blue RAL 5012)			
Battery-connection	M8 bolts			
230 V AC-connection	screw-clamp 10 mm ²			
Protection category	IP 21			
Weight (kg)	15	21	15	21
Dimensions (H x W x D in mm)	492x258x218			
STANDARDS				
Safety	EN 60335-1, EN 60335-2-29			
Emission	EN 50081-1, EN55014, EN 61000-3-2, EN 61000-3-3			
Immunity	EN 55014-2			
UL	UL458			
Automotive Directive	95/54/EC			

5. APPENDIX

A Overview connections

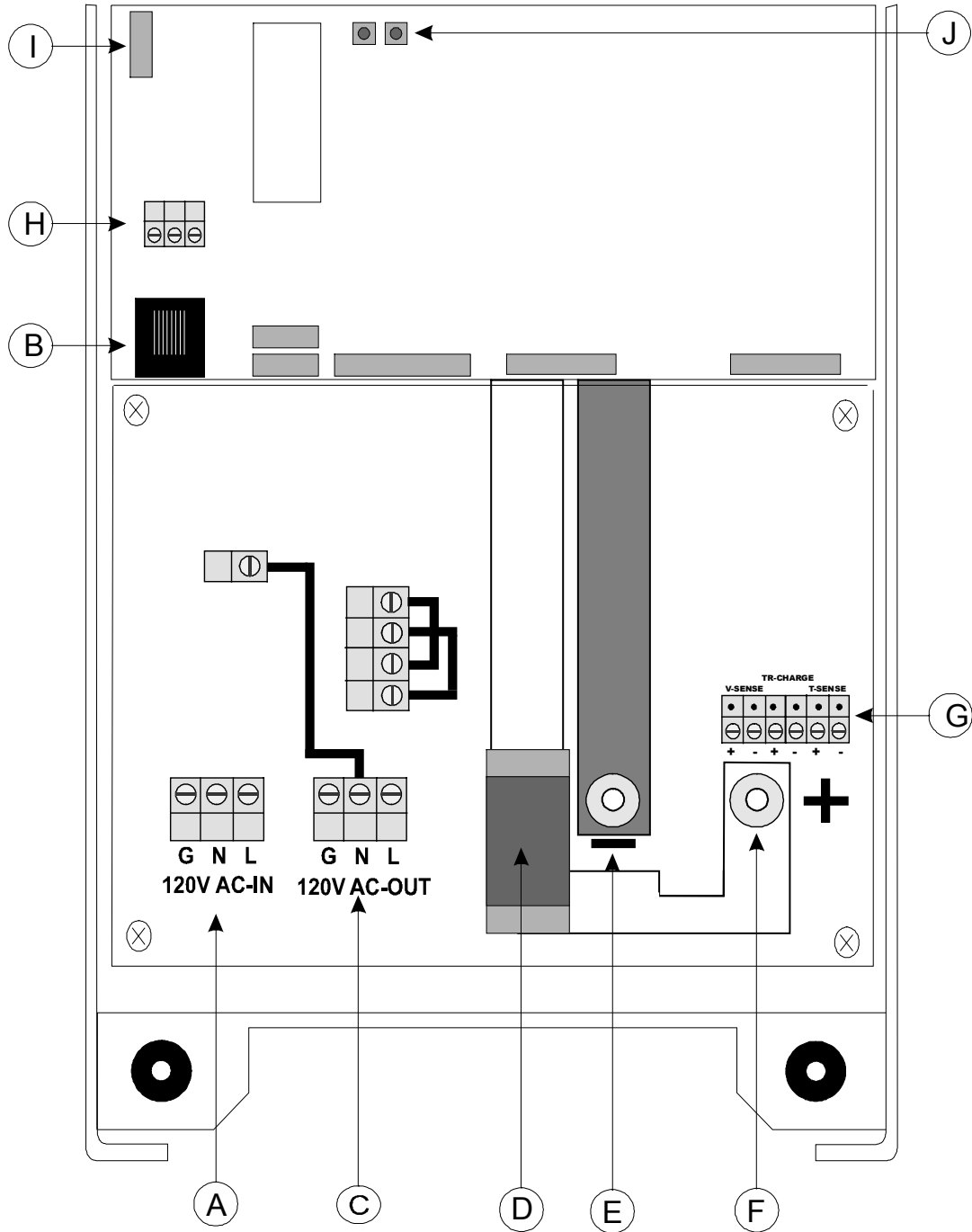

A	Shore supply. AC in: (left to right) PE (ground), N (neutral), L (phase).
B	Connector for remote panel.
C	Load connection. AC out: (left to right) PE (ground), N (neutral), L (phase).
D	Megafuse F4.
E	Battery minus.
F	Battery plus.
G	Terminals for: (left to right) Voltage sense plus, Voltage sense minus, Starter battery plus, Starter battery minus, Temperature sensor plus, Temperature sensor minus.
H	Connections for remote switch: Short left and middle terminal to switch the Multi "on", Short right and middle terminal to switch the Multi to "charger only".
I	Dipswitches DS1 tm DS8 for set-up mode.
J	Pushbuttons for set-up mode.
K	Used for Parallel and 3-Phase operation, J7 IN.
L	Used for Parallel and 3-Phase operation, J8 OUT.
M	"Reversed polarity" LED.

B Dimensions

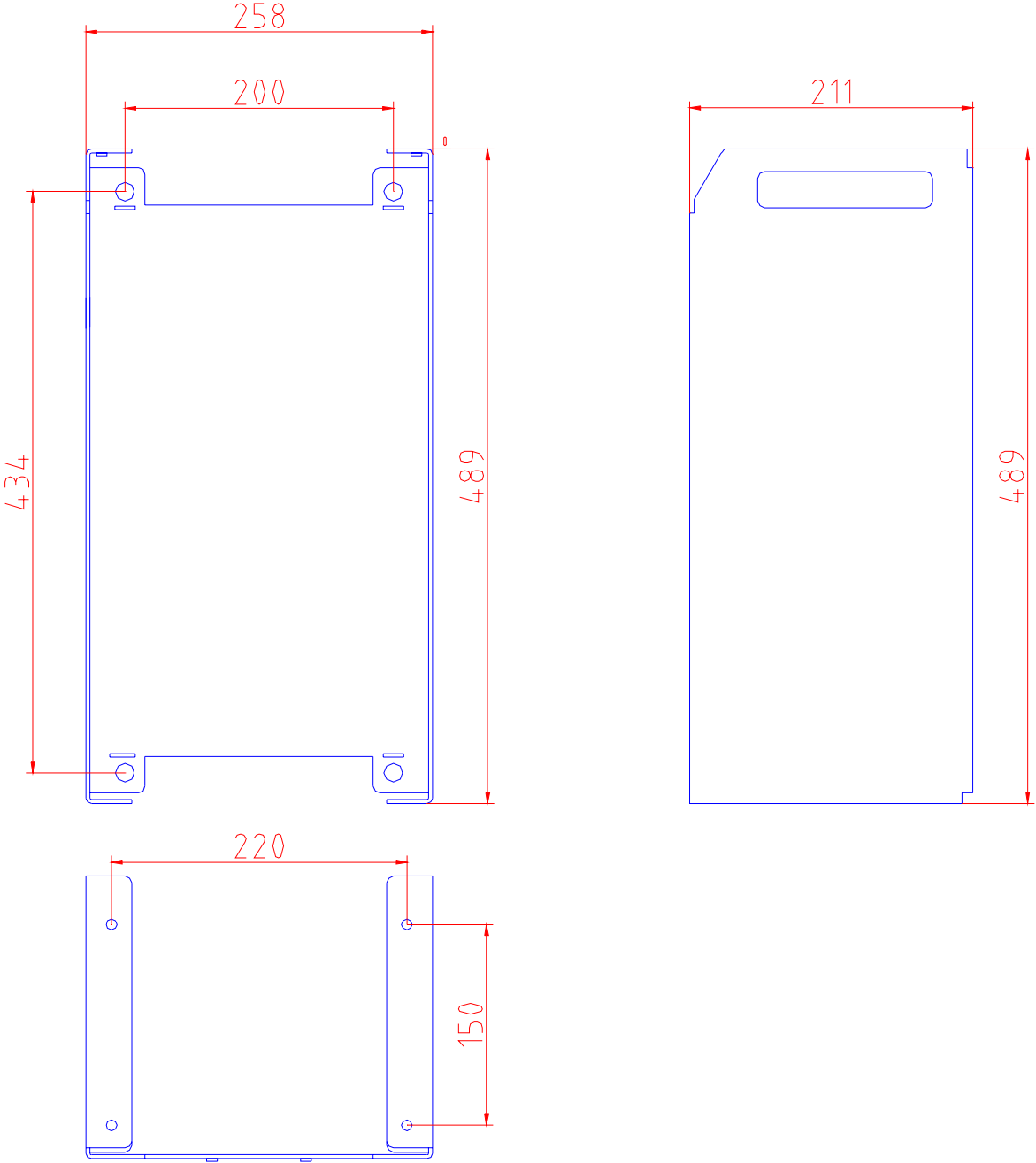

C Charge characteristics

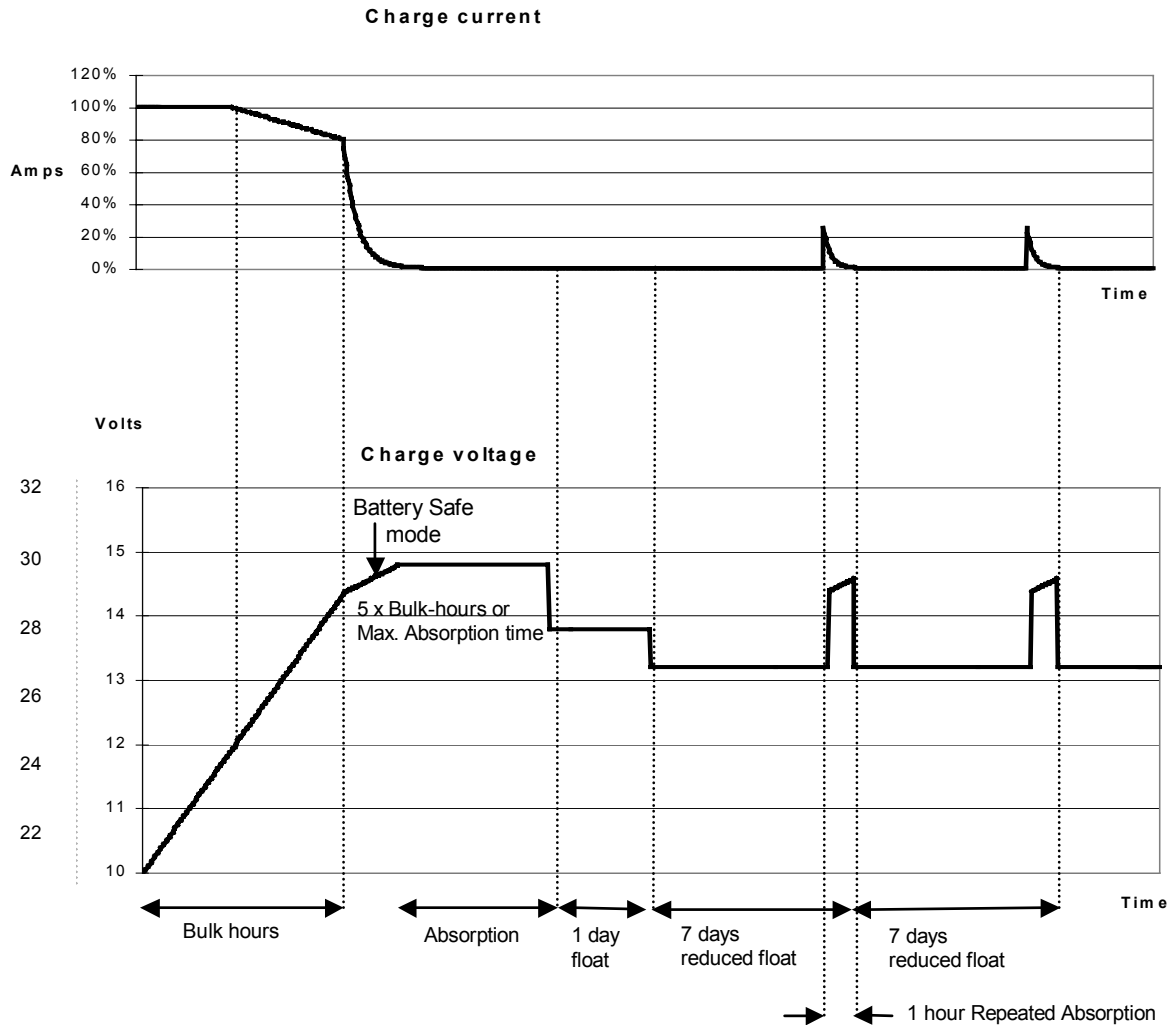

4-stage charging:

Bulk-mode: Entered when charger is started. Constant current is applied until nominal battery voltage is reached, depending on temperature and input voltage, after which constant power is applied up to the point where excessive gassing is starting (14.4V resp. 28.8V, temperature compensated).

Battery Safe Mode: The applied voltage to the battery is raised gradually until the set Absorption voltage is reached. The Battery Safe Mode is part of the calculated absorption time.

Absorption-mode: Absorption voltage is applied until $\{\text{actual-Bulk-Ah} \cdot 5 / \text{max.adjusted-Bulk-current}\}$ (in hours) is reached. Usually $\{\text{actual-Bulk-Ah} \cdot 5\} = \{\text{max.adjusted-Bulk-current} \cdot \text{Bulk-hours} \cdot 5\}$, but the actual-Bulk-current can be limited by ambient temperature, or remote control. The maximum time in Absorption mode is the Maximum Absorption time set.

Float-mode: Float voltage is applied to keep the battery fully charged and to protect it against self-discharge.

Reduced Float: After one day of Float charge a reduced Float charge is applied. This is 13.2V resp. 26.4V (for 12V and 24V charger). This will limit water loss to a minimum when the battery is stored for the winter season.

After an adjustable time (default = 7 days) the charger will enter Repeated Absorption-mode for an adjustable time (default = 4 quarters).

D Temperature compensation

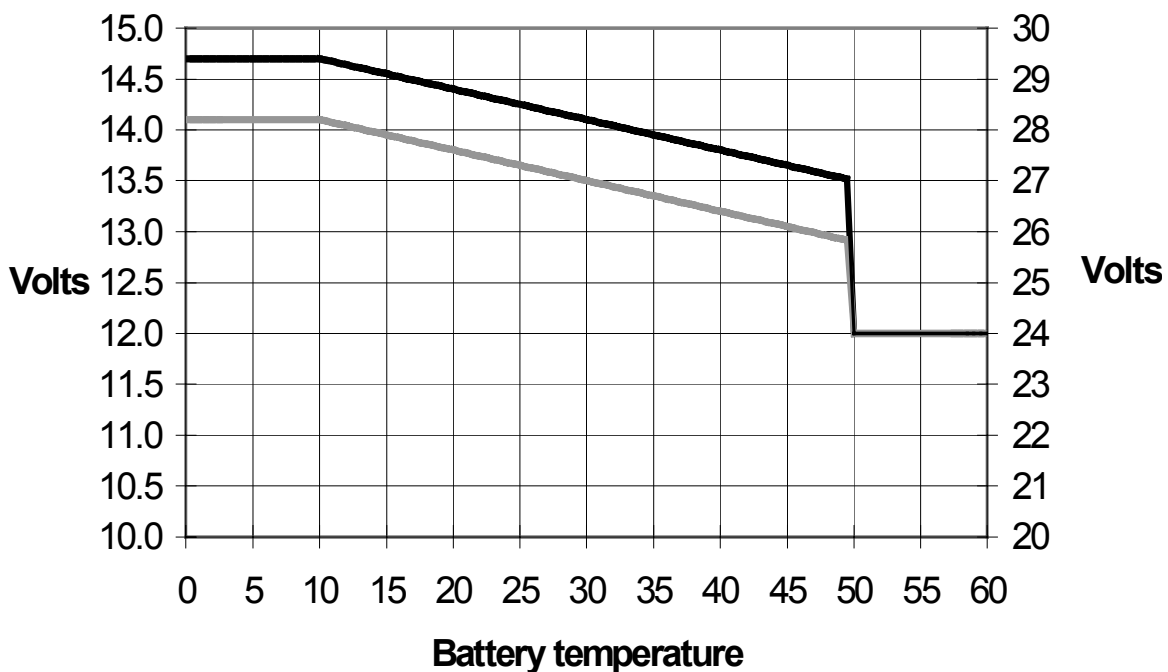

Default output voltages for Float and Absorption are at 20°C. Reduced Float voltage follows Float voltage and Raised Absorption voltage follows Absorption voltage. In adjust mode temperature compensation does not apply.

E Star connect schematic

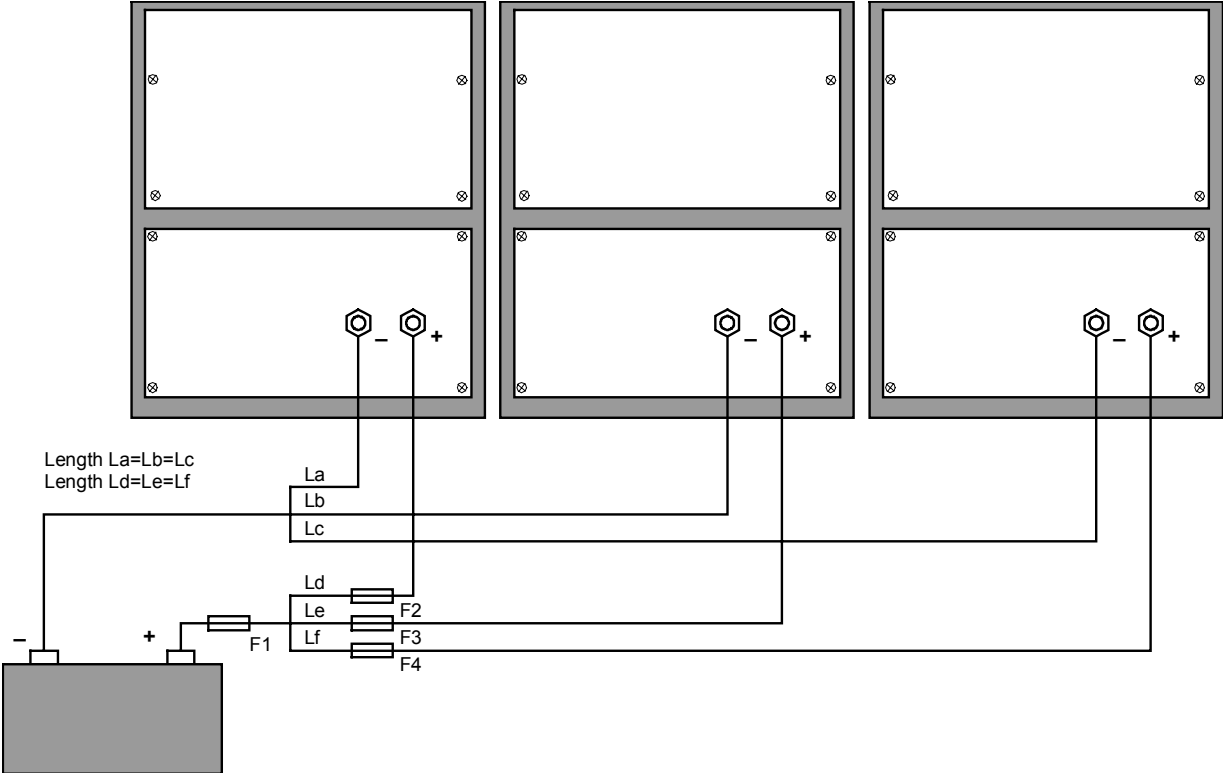

F Rail connect schematic

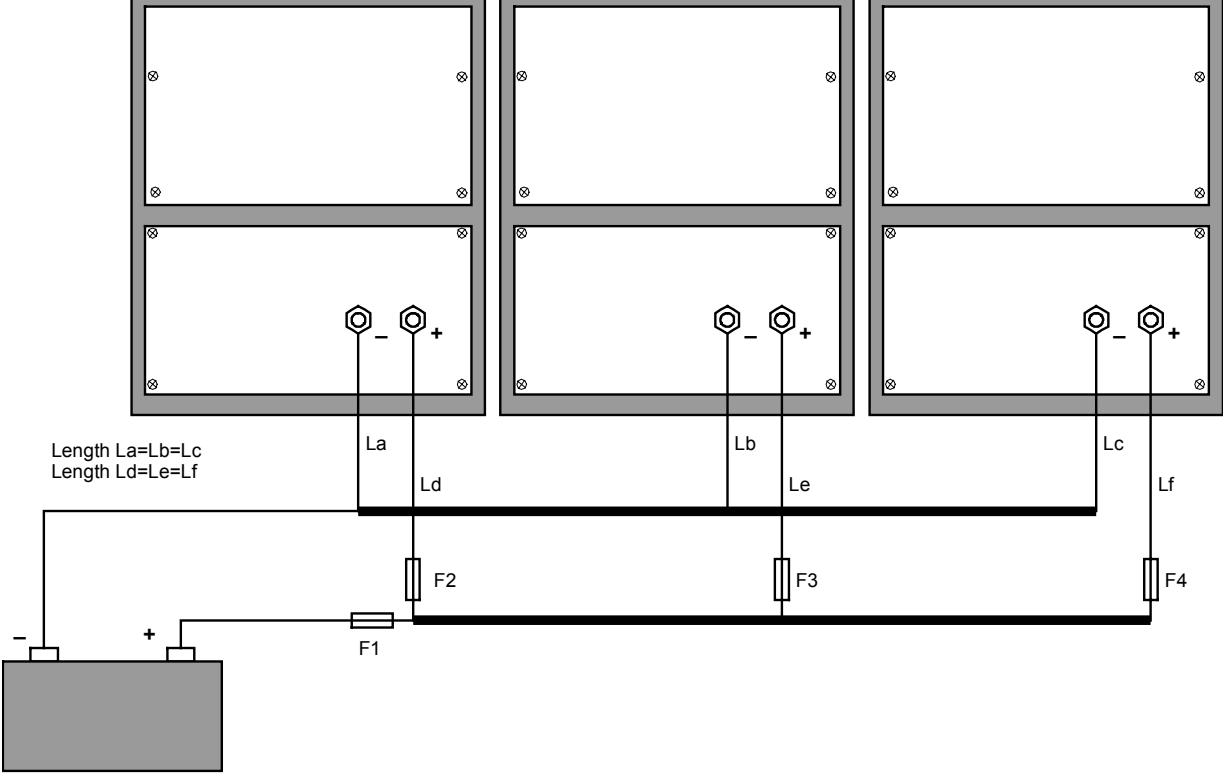

G Parallel connect schematic

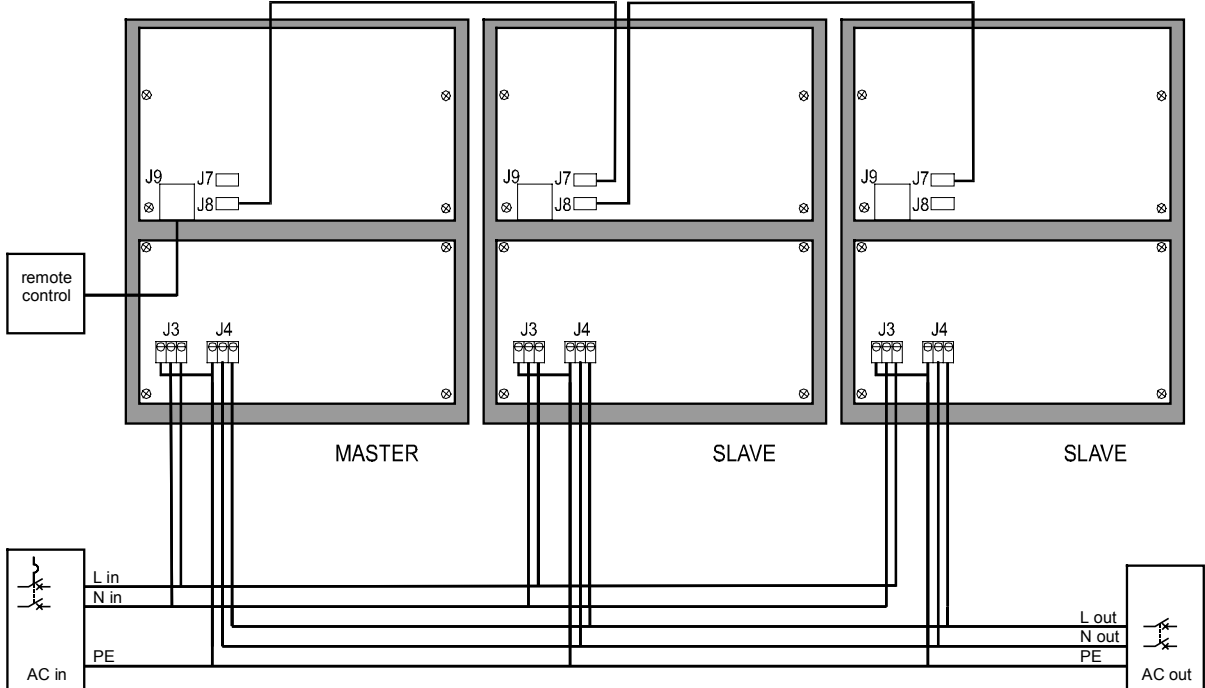

3-Phase connect schematic

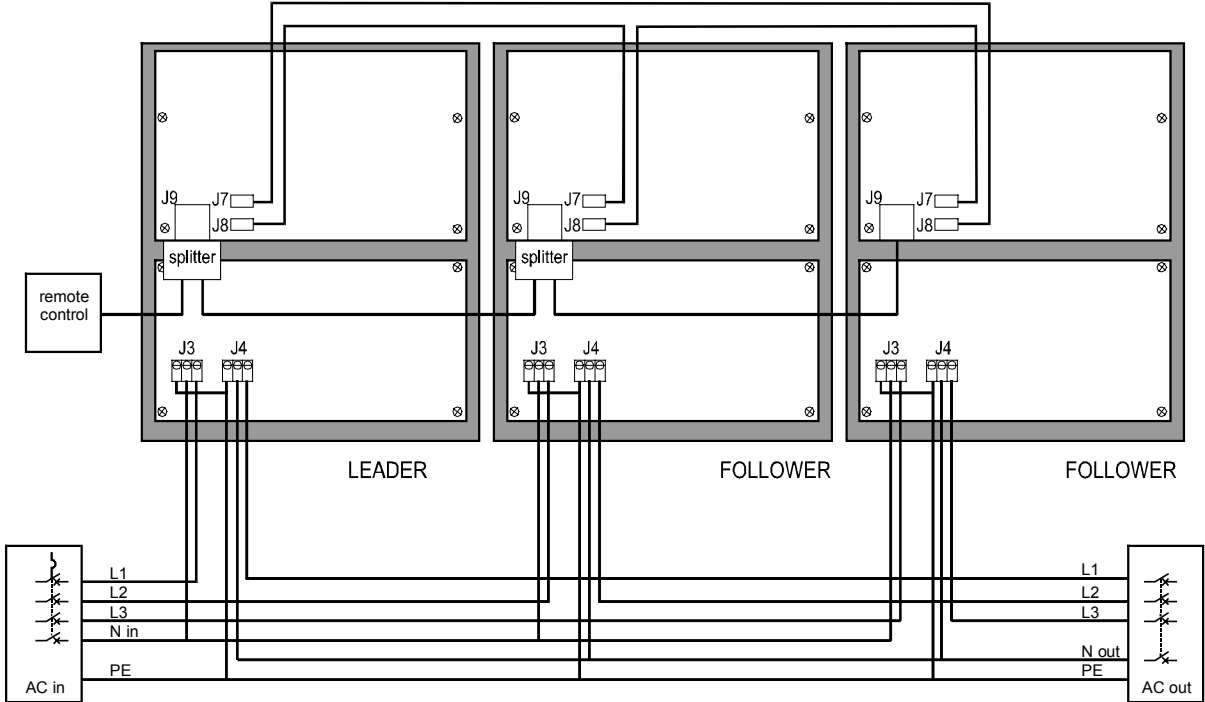

Serial number:

Distributor:

Victron Energy B.V.

The Netherlands

General phone: +31 (0)36 535 97 00

Customer support desk: +31 (0)36 535 97 77

General and Service fax: +31 (0)36 531 16 66

Sales fax: +31 (0)36 535 97 40

E-mail: sales@victronenergy.com

Internet site: <http://www.victronenergy.com>

Article number: ISM010056000

Version: 00

Date: 01-01-2003