

from SN batch HQ2443 onwards

Dimension Drawing - MultiPlus-II  
PMP482805000 MultiPlus-II 48/8000/110-100 230V

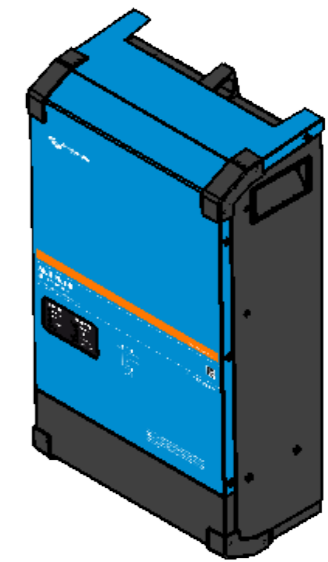

Dimensions in mm

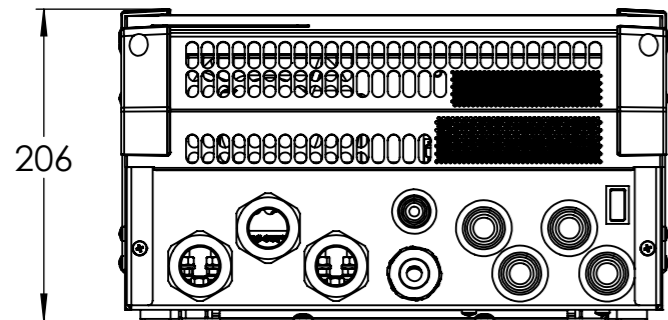
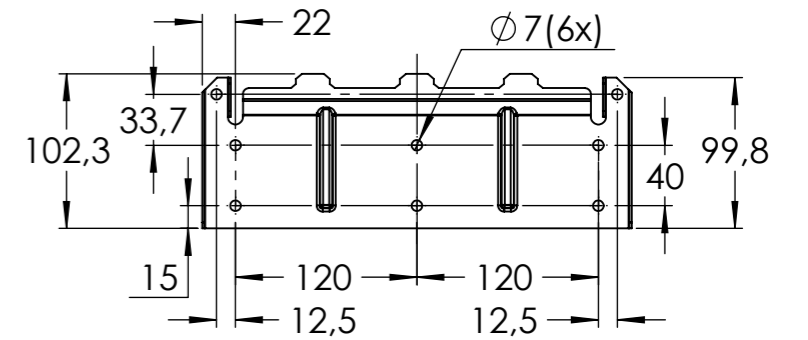
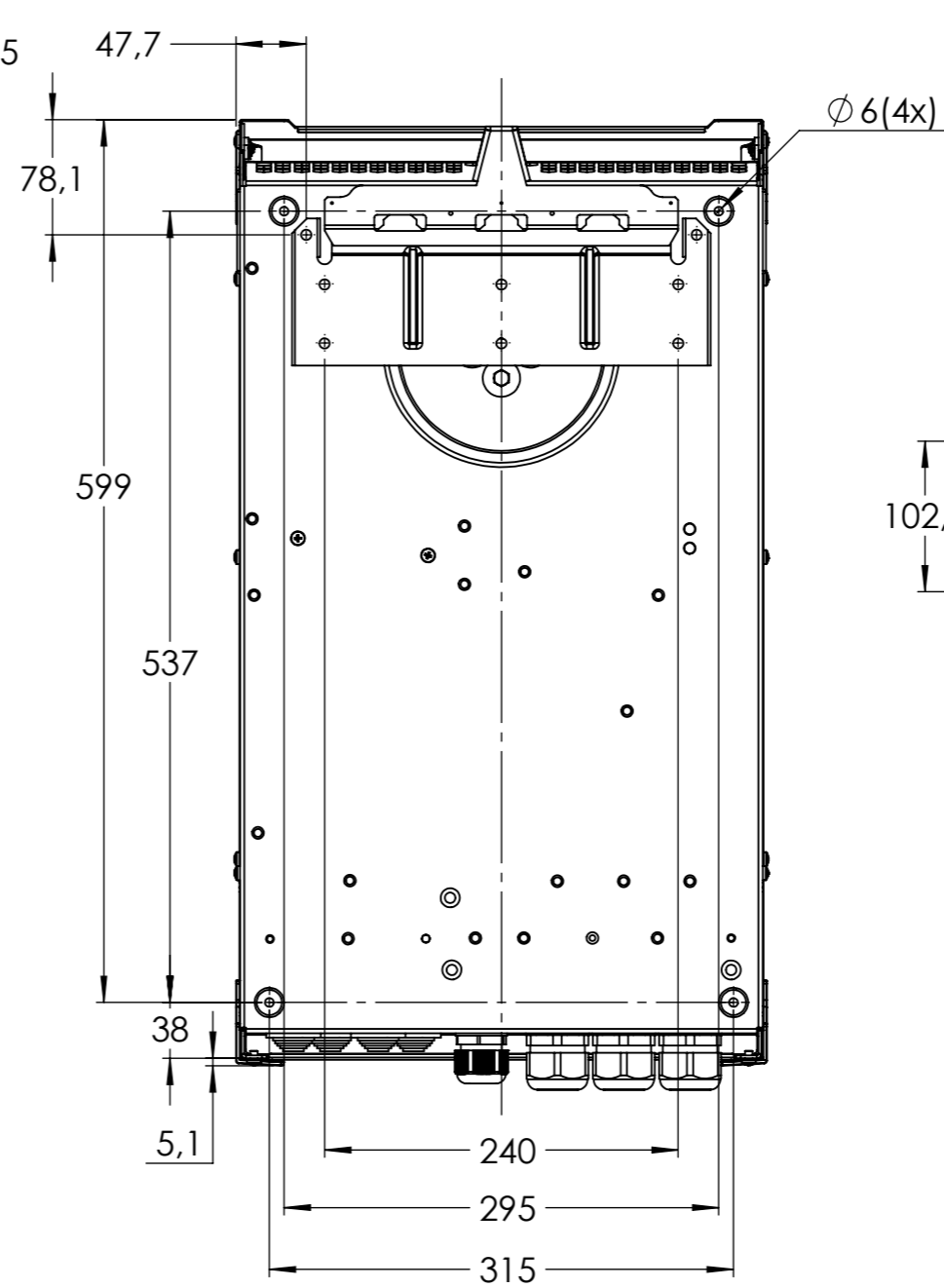
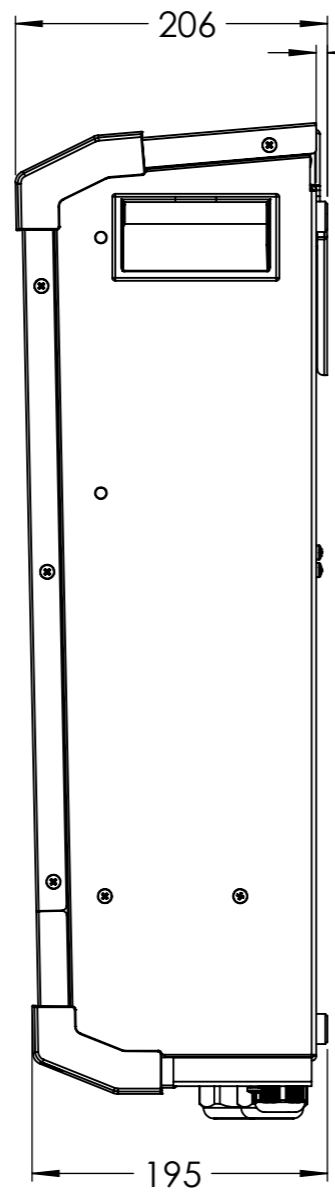
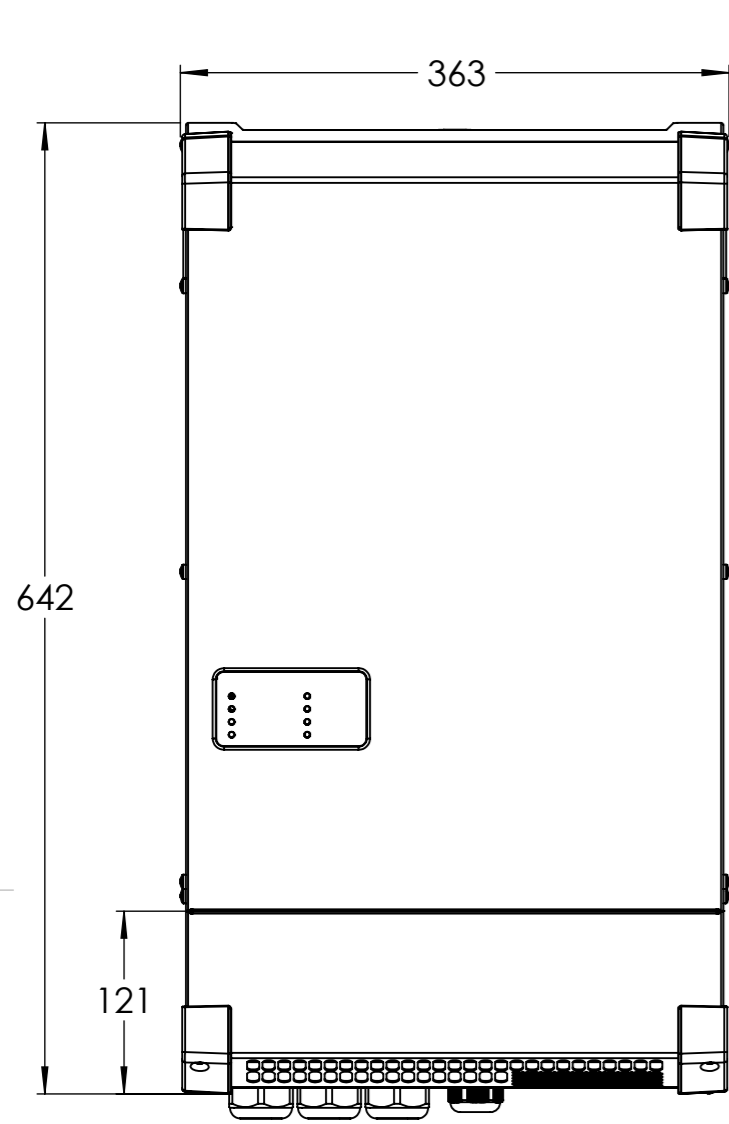